

AMERICAHEARS[®]

Helping People Hear Better

ESSENTIAL

PRO

ELITE

ELITE +

SELECT PRO

Welcome To America Hears®

We're happy to help you on your journey to better hearing!
Please take a couple of minutes to get familiar with your new hearing aids.

Get Started

Visit [americahears.com/support-videos](https://www.americahears.com/support-videos) and discover our videos made just for you.
You can also find a digital version of this manual at [americahears.com](https://www.americahears.com)

If you need any help, give us a call at 800.492.4515
or talk to us via live chat at [americahears.com](https://www.americahears.com).

powered by **Lucid**®

America Hears uses powered by Lucid technology.

Learn more about Lucid Technology® at www.americahears.com

WARNING: People younger than 18 should go to a doctor before using this.

People younger than 18 years old need specialized care, and using this without a medical evaluation may worsen impairment or disability. A hearing aid user who is younger than 18 should have a recent medical evaluation from a doctor, preferably an ear-nose-throat doctor (an ENT).
Before using this, a doctor should determine that the use of a hearing aid is appropriate.

WARNING to Hearing Aid Dispensers:

You should advise a prospective hearing aid user to consult promptly with a doctor, preferably an ear specialist such as an ENT, before dispensing a hearing aid if you determine through inquiry, actual observation, or review of any other available information concerning the prospective user, that the prospective user has any of the following conditions:

- Visible deformity of the ear, either congenital or traumatic
- Fluid, pus, or blood coming out of your ear in the past 6 months
- Painful or discomfort in the ear
- History of excessive ear wax, or suspicion that something is in the ear canal
- Dizziness, either recent or long-standing
- Sudden, quickly worsening, or fluctuation hearing loss within the previous 6 months
- Hearing loss or ringing (tinnitus) only in one ear or a noticeable difference in hearing between ears
- Audiometric air-bone gap equal to or greater than 15 dB at 500 Hz, 1000 Hz, and 2000Hz

Special care should be exercised in selecting and fitting a hearing aid whose maximum sound pressure level exceeds 132 decibels as there may be risk of impairing the remaining hearing of the hearing aid user. (This provision is required only for those hearing aids with a maximum sound pressure capability greater than 132 decibels (dB)).

Caution: This is not hearing protection.

You should remove this device if you experience overly loud sounds, whether short or long-lasting. If you're in a loud place, you should use the right kind of hearing protection instead of wearing this device. In general, if you would use ear plugs in a loud place, you should remove this device and use ear plugs.

Caution: The sound output should not be uncomfortable or painful.

You should turn down the volume or remove the device if the sound output is uncomfortably loud or painful. If you consistently need to turn the volume down, you may need to further adjust your device.

Caution: You might need medical help if a piece gets stuck in your ear.

If any part of your hearing aid, like the ear tip, gets stuck in your ear, and you can't easily remove it with your fingers, get medical help as soon as you can. You should not try to use tweezers or cotton swabs because they can push the part farther into your ear, injuring your eardrum or ear canal, possibly seriously.

Note: What you might expect when you start using a hearing aid

A hearing aid can benefit many people with hearing loss. However, you should know it will not restore normal hearing, and you may still have some difficulty hearing over noise. Further, a hearing aid will not prevent or improve a medical condition that causes hearing loss.

People who start using hearing aids sometimes need a few weeks to get used to them. Similarly, many people find that training or counseling can help them get more out of their devices.

If you have hearing loss in both ears, you might get more out of using hearing aids in both, especially in situations that make you tired from listening—for example, noisy environments.

Note: Tell FDA about injuries, malfunctions, or other adverse events

To report a problem involving your hearing aid, you should submit information to FDA as soon as possible after the problem. FDA calls them "adverse events," and they might include: skin irritation in your ear, injury from the device (like cuts or scratches, or burns from an overheated battery), pieces of the device getting stuck in your ear, suddenly worsening hearing loss from using the device, etc.

Instructions for reporting are available at <https://www.fda.gov/Safety/MedWatch> or call 1-800-FDA-1088. You can also download a form to mail to FDA.

Note: Hearing loss in people younger than 18

- People younger than 18 should see a doctor first, preferably an ear-nose-throat doctor (an ENT), because they may have different needs than adults
- The doctor will identify and treat medical conditions as appropriate
- The doctor may refer the person to an audiologist for a separate test, a hearing aid evaluation
- The hearing aid evaluation will help the audiologist select and fit the appropriate hearing aid

A person who is younger than 18 years old with hearing loss should have a medical evaluation by a doctor, preferably an ENT, before buying a hearing aid. That purpose of a medical evaluation is to identify and treat medical conditions that may affect hearing but that a hearing aid won't treat on its own.

Following the medical evaluation and if appropriate, the doctor will provide a written statement that the hearing loss has been medically evaluated and the person is a candidate for a hearing aid. The doctor may refer the person to an audiologist for a hearing aid evaluation, which is different from a medical evaluation and is intended to identify the appropriate hearing aid.

The audiologist will conduct a hearing aid evaluation to assess the person's ability to hear with and without a hearing aid. This will enable the audiologist to select and fit a hearing aid for the person's individual needs. An audiologist can also provide evaluation and rehabilitation since, for people younger than 18, hearing loss may cause problems in language development and educational and social growth. An audiologist is qualified by training and experience to assist in the evaluation and rehabilitation of hearing loss in people younger than 18.

What's In The Box



Hearing Aid(s)



Receiver tube(s)



Variety Pack Ear Tips



10x Wax Stops



Hard Case



Cleaning Brush



Drying Jar



For our non-rechargeable model:
40 Pack of Batteries



For our rechargeable model:
1 Charging Case
USB Power Cord

Getting To Know Your Device

THE NON-RECHARGEABLE MODEL

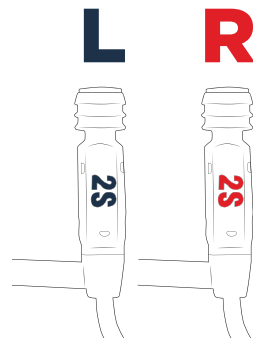
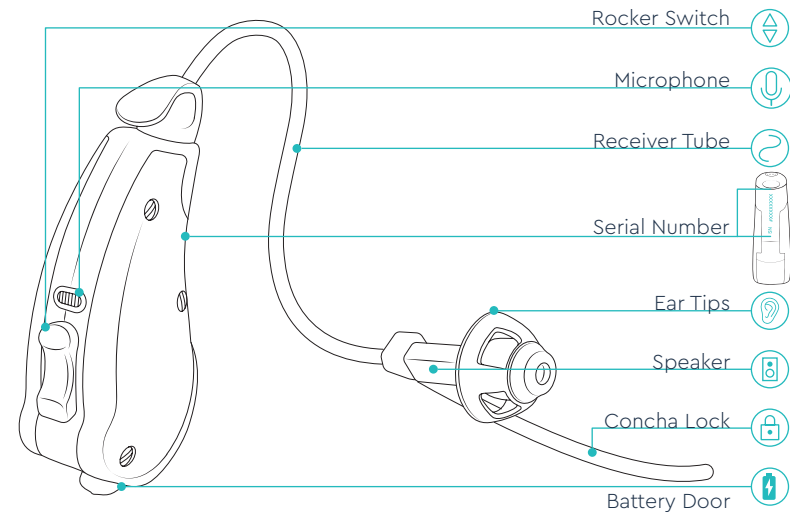

Battery Replacement

Your hearing aids are powered by a **size 312 battery**. These batteries last for a total of 85 hours. Anytime the battery is low, every 15–20min you will be prompted by the hearing aids to change the battery.

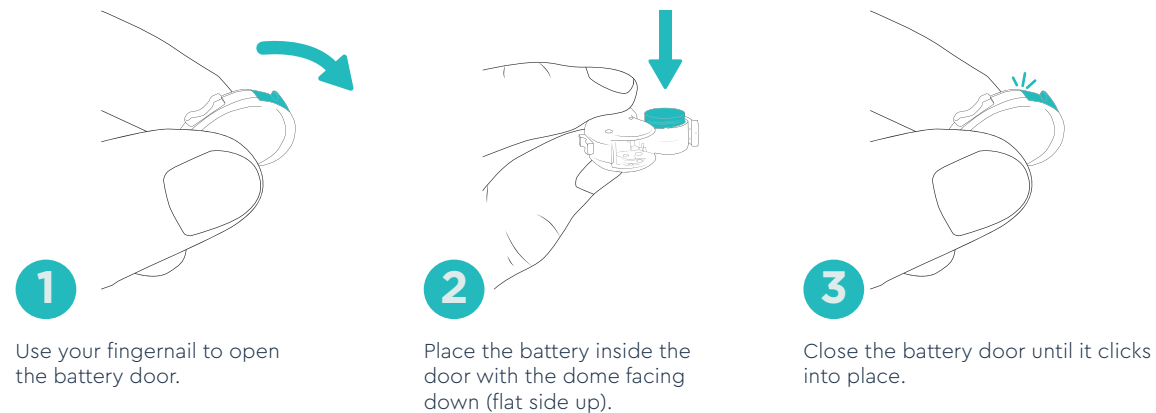

NOTE: Do not force battery door close. Battery door should click into place.

Getting To Know Your Device

THE RECHARGEABLE MODEL

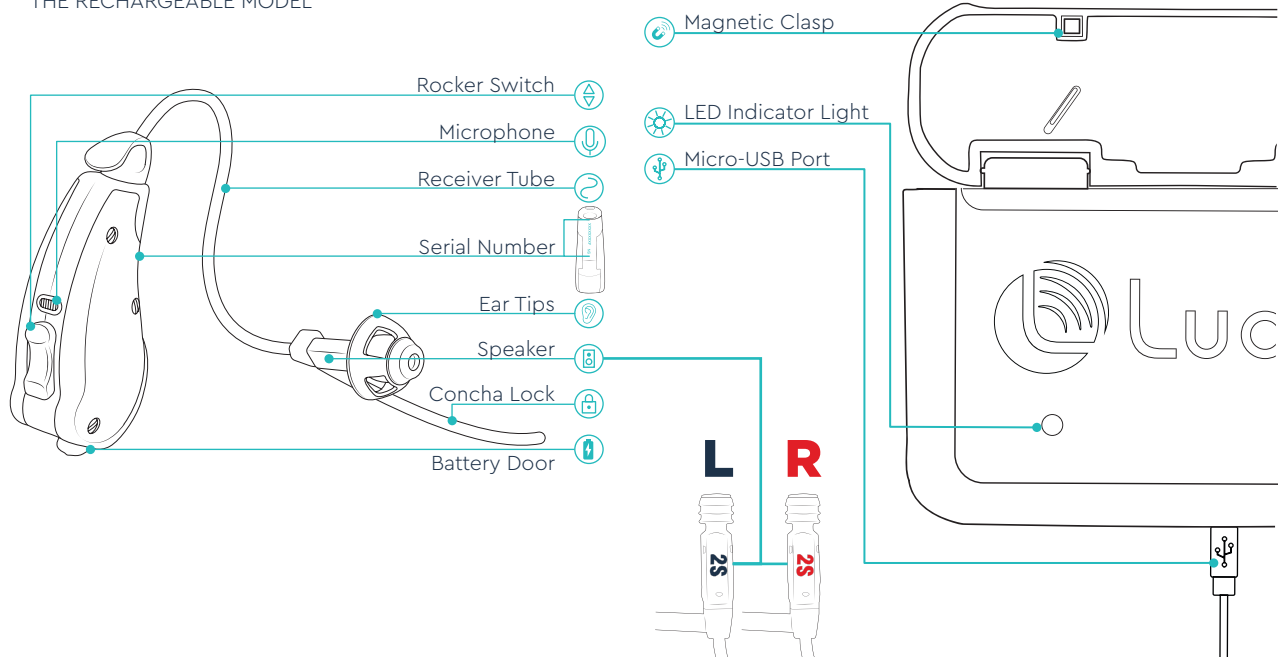

Finding Your Fit

THERE ARE 5 DIFFERENT TYPES OF EAR TIPS

If you are experiencing whistling (feedback) try our closed style tips. For a more natural sound use open style ear tips.

Closed Fit



Tulip: Moderate whistle block with added stability.



Vented Dome: Increased whistle block with added stability.



Double Dome: Maximum whistle block and stability, but a less natural fit.

Open Fit



Extra Small: For experiencing more natural sound.



Open Fit: For experiencing more natural sound with stability.

Changing Your Ear Tip

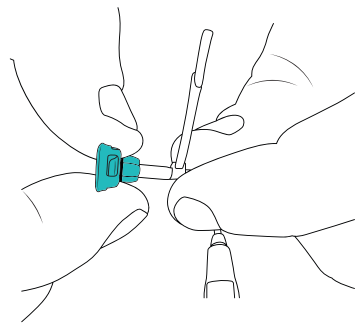

Gently grab the sound tip in one hand, pinch the bottom of the ear tip with the other hand and peel the ear tip off of the sound tip.

The ear tips are made out of silicone so they will stretch.

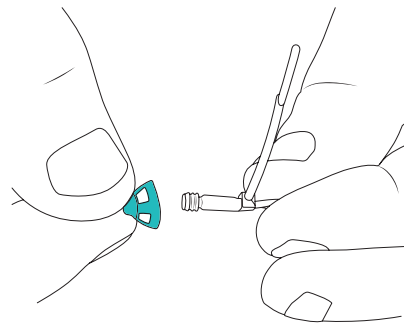

Once the sound tip is exposed, pinch the top of the new ear tip and press it onto the sound tip.

Congrats, you have replaced your ear tips!

NOTE: Improper replacement could result in the ear tip coming off of the receiver and being lodged in the ear canal.

Inserting Your Hearing Aid

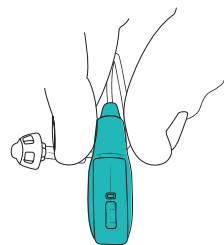

Step 1

Pinch the hearing aid from the top of the body.

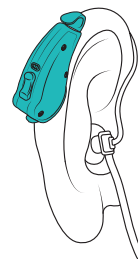

Step 2

Hook the body of the hearing aid over the ear.

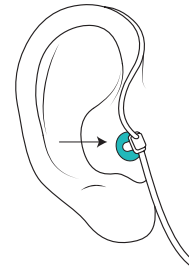

Step 3

Gently position the speaker in the ear canal with the ear tip **fully inserted**.

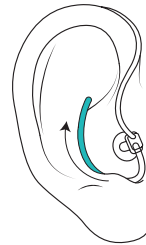

Step 4

Lastly, to secure the device, tuck the concha lock inside the **bowl of the ear**.

You're now ready to hear better!

Cleaning and Maintenance

HOW TO USE A WAX STOP

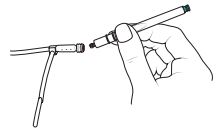

Step 1

Line up the wax stop with the receiver.



Step 4

Rotate the wax stop.

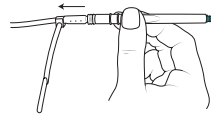

Step 2

Insert the wax stop into the basket.

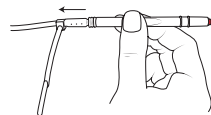

Step 5

Insert the new basket into the receiver.

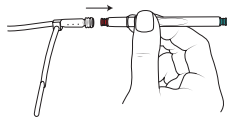

Step 3

Pull out the wax stop with the used basket attached.

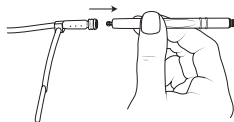

Step 6

Pull the wax stop out once the basket has been lodged in the receiver.

NOTE: Improper replacement of wax stop could result in the wax stop coming out of the receiver and being lodged in the ear canal.

Cleaning and Maintenance

ADDITIONAL INFORMATION

The most common **cause of hearing aid failure is wax build up.**

SOLUTIONS:

- Use acoustic cleaning tool
- Change ear tips
- Use cleaning brush
- Wipe with dry cloth

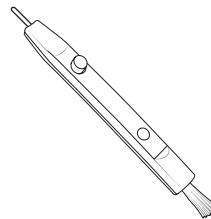

Why open the battery door when not in use?

ANSWER:

- Improved battery life
- Eliminate whistle (feedback)
- Minimize moisture buildup

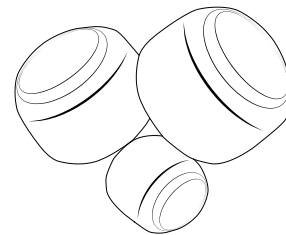

Why use the drying jar?

ANSWER:

- Increase hearing aid lifespan
- Eliminates moisture

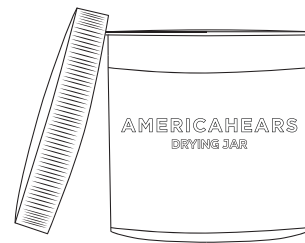

How to Use Your Hearing Aids

The rocker switch acts both as a volume control and as a program selector.

- + Increase volume
- Decrease volume

Cycle through programs: Long press + or -

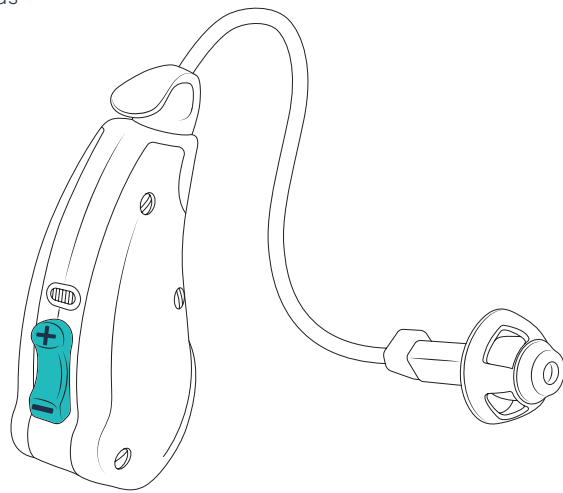

How to Control the App

Take advantage of all the features and benefits your hearing aids offer by downloading the **Lucid Hearing app!**

Once downloaded, open the app to control the volume, audio streaming, and more!

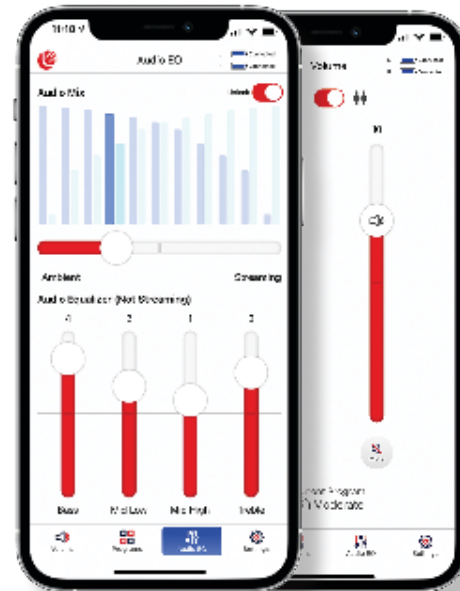

Connect Your Hearing Aids

- 1 You can connect to the app while wearing your hearing aids or by simply placing them next to your phone.
- 2 The app will display available hearing aids for connecting. Your hearing aids should appear here. Press connect.
- 3 A confirmation will appear after the pairing is complete.



Navigating the App

Open the app and follow the prompts to connect your hearing aids. Feel free to explore each tab listed in the Lucid Hearing App.

Volume – Control the volume of both hearing aids or each individually.

Programs – These profiles fit our ever-changing environments. If you want to create a custom profile you can **call 800.492.4515** and we'll help you set one up.

Audio Equalizer – When you are audio streaming or making phone calls, you can adjust the Bass, Mid Low, Mid High, and Treble ranges, as well as adjust the balance between ambiance and audio streaming.

Settings – See your hearing aid's battery life and more information about the app.

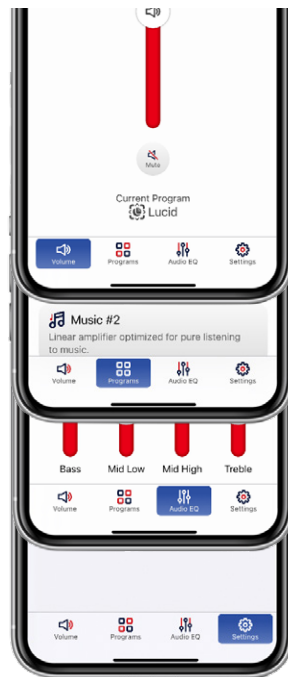

Rechargeable Case Module

FOR RECHARGEABLE MODELS ONLY

With the easy-to-use charging case, it's as simple as placing the hearing aids inside the case as shown.

Anytime the hearing aid's **battery is low**, every 15–20min you will be prompted by the device to change the battery.

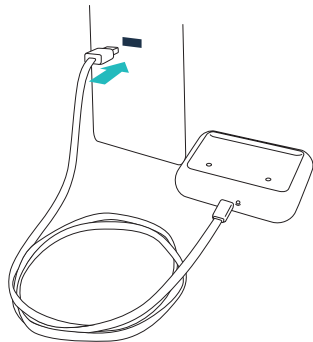

To charge the Battery Case use the micro-USB cable to plug into a power source. Battery case' life expectancy is 3 years or 1000 cycles of charging, whichever comes first.

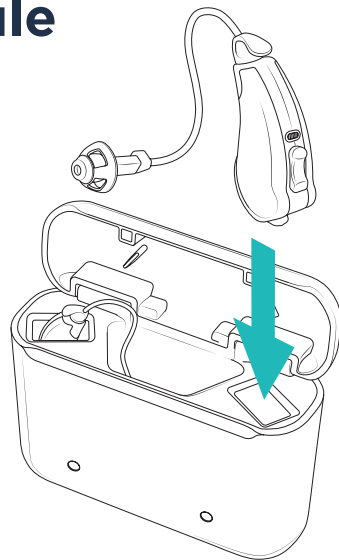

That's it. The blinking LED indicator on the front of the case lets you know that your hearing aids are charging.

Charging Light Indicators

CARRYING CASE FRONT VIEW



Fully Charged:

The steady green light will indicate the device is fully charged.



Active Charging:

Pulsing green lights indicate the device is charging.

CARRYING CASE BOTTOM VIEW



No Connection:

A pulsating orange light will appear indicating the case looking for a USB connection.



Active Charging:

A constant orange light indicates the device is charging.



Fully Charged:

A constant green light indicates the device is fully charged.

Battery Information

HOW TO READ YOUR BATTERY

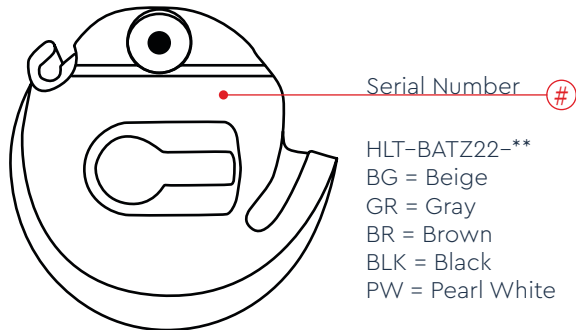

“Expected” Lithium Sized Batteries

Battery Module contains Lithium-ion button cell
UL1642 certified /UN38.3 certified
IEC 62133-2:2017 certified

Rating: 3.8v d.c, 17.mAh, 0.067Wh

Charger contains Lithium-ion Polymer Battery

Model: PD 502070

Rating: 5.0V, 820mAh, 3.034Wh

UN38.3 certified

IEC 62133-2:2017 certified

Troubleshooting

You want to make sure a few things are taken care of when connecting to the app:

- Phone's Bluetooth is turned on.
- Hearing aids are out of the case.
- Hearing aids are fully charged.
- Open the hearing aid battery door to turn off the hearing aid and close the battery door to turn on the hearing aid. This also resets the hearing aid.
- Phone is updated to the latest software.

**Getting little or no sound?
Check these tips:**

- Ensure the receiver is connected.
- Charge your battery. (Rechargeable model)
- Change your battery. (Non-rechargeable model, size 13)
- Call 800.492.4515 if you still need help.
- Check your wax stops and clean out any debris.

ANSI Spec Sheet

HiFit 125 Receiver

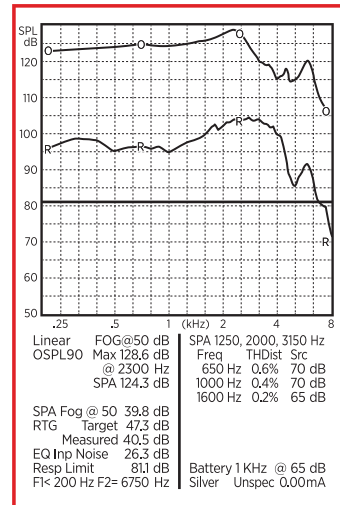

HiFit 110 Receiver

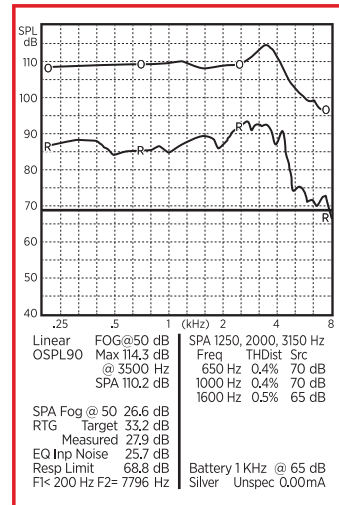

DWT Receiver

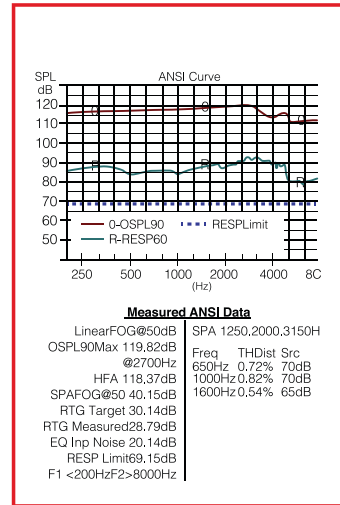

About powered by Lucid® Hearing Aids

powered by Lucid hearing aids are highly sophisticated devices which have the capacity to make a real impact on the overall quality of life for those who have hearing loss.

Patented Lucid Smart Technology delivers natural sound quality that is superior to traditional “compression” hearing aid technology. powered by Lucid hearing aids help you hear the sounds that are most understandable and comfortable volume. Our Lucid technology constantly analyzes your environment making automatic adjustments to ensure you hear what you want to hear while minimizing noise and sounds you don’t want to hear. This allows you to move from one sound environment to another, like a one-on-one conversation and then a noisy group, without having to make adjustments to your hearing aid settings.

While our hearing aids won’t restore your hearing to normal, you will experience a very positive difference. These differences vary between individuals and depend on a number of factors including your level of hearing loss and the type of hearing aid you choose. Our Lucid Certified Hearing Specialists are committed to fitting you with the best device for your level of loss and unique lifestyle.

Important Hearing Aid Information

The device (custom programmed for individual hearing loss) must only be used by the intended person. The hearing devices should not be used by any other person as they could damage the individual's hearing.

The instruments are not intended for infants, small children or mentally disabled persons.

Getting Started

Helpful Hints:

- Start in quiet places with simple communication and then progress as you feel comfortable.
- A positive mindset is critical as your neuro system adjusts to your new hearing aid device. It takes time to adapt.
- Communicate any issues with your hearing care professional; they can make adjustments as necessary.
- Hearing aids will not restore normal hearing and will not prevent or improve a hearing impairment resulting from organic conditions.

- In most cases infrequent use of a hearing aid does not permit a user to attain full benefit from it.
- The use of a hearing aid is only part of hearing habilitation and may need to be supplemented by auditory training and instruction in lip-reading.

General Instrument Care

Your instruments are delicate, precision electronic devices and require special care and handling that should be provided to such devices. Please read and follow the listed precautions to ensure quality performance and long instrument life.

- **Remove** batteries when hearing instruments will not be in use for prolonged periods of time
- **Do not throw** or drop your instruments
- **Do not** immerse hearing instruments in liquid or water
- **Do not** wear during bathing, showering or swimming
- **Store out of the reach of children and pets**
- **Do not** expose instruments to excessive heat, such as stove top, microwave, dashboard of a hot car, or hair dryer

- **Do not** expose the instruments to chemicals such as hair spray, insect repellent, perfume, or cosmetics
- **Do not** use the product with higher volume for a long period of time, in order to avoid hearing damage. Stop using if discomfort occurs.
- **Do not disassemble** the device.
- **To avoid possible electromagnetic radiation**, the devices should be removed in any high frequency, heat treatment or operation, radiotherapy and strong magnetic field environments
- **Please avoid use in a potentially explosive or oxygen-enriched environment.**
- Only qualified accessories should be used with this device.
- Take off the hearing aid at night, which should be placed in stay dry jar (hearing aid specialist can supply), avoid light, high temperature, high humidity environment, or falling touch.
- **Please keep the surface of the hearing aid clean**, clean wax buildup in the wax stop.
- **Please use the Dual Function Rocker Switch correctly**, avoid excessive force as much as possible.

Special Note: Your hearing instruments are built with the finest quality materials. However, in rare instances an individual may experience sensitivity to the materials used. Please consult with your physician if you exhibit any signs of skin irritation, allergic reaction, or accelerated accumulation of cerumen (wax).

Should you experience a sensitivity problem, please see your hearing care provider to inquire about special hypoallergenic coatings available to assist with these situations.

If your instrument is equipped with wireless capabilities, check first before using the hearing instrument in areas where electronics or wireless devices are restricted such as on an airplane.

Note: Your Hearing Care Professional can perform a thorough professional cleaning and maintenance. It is recommended that you contact your hearing care professional at least annually for a new hearing test and a clean and check of your device.

The average hearing aid lifespan will vary significantly due to the amount of care provided and the use conditions. On average the life expectancy is approximately 4 years. The lifespan of consumable supply items will also vary significantly (i.e. wax stops) Ask your Hearing Care Professional for recommendations on supplies and maintenance intervals and for support.

Battery Safety Information

Hearing Aid Batteries Are Dangerous If Swallowed.

Keep out of the reach of children or anyone who may accidentally swallow them. Never put batteries in your mouth for any reason. Do not store batteries in pill containers where they may be mistaken for medication and swallowed. Use batteries recommended by your hearing care professional. Batteries of low quality may leak and cause bodily harm. Batteries with incorrect voltage may cause damage to your device. Never attempt to recharge your batteries. They may explode and cause serious injury. Do not expose your batteries to heat, such as an open flame, microwave, or oven. There is a risk that they will explode and cause serious injury. Please discard old batteries in a safe place.

Visit <http://www.poison.org/prevent/battery.asp> to learn more important information about battery safety.

If a battery or hearing instrument is swallowed, see a doctor immediately and call the National Capital Poison Center, 202-625-3333.

IMPORTANT NOTICE

Prospective Hearing Aid Users: Good health practice requires a person with a hearing loss to have a medical evaluation by a licensed physician (preferably a physician who specializes in diseases of the ear) before purchasing a hearing aid. Licensed physicians who specialize in the disease of the ear are often referred to as otologists, otolaryngologists, or otorhinolaryngologists. The purpose of a medical

evaluation is to assure all medically treatable conditions that may affect the hearing are identified and treated before the hearing aid is purchased.

Following the medical evaluation, the physician will give you a written statement stating your hearing loss has been medically evaluated and you may be considered a candidate for a hearing aid. The physician will refer you to an audiologist or a hearing aid dispenser, as appropriate, for a hearing aid evaluation.

The audiologist or hearing aid dispenser will conduct a hearing aid evaluation to assess your ability to hear with and without a hearing aid. The hearing evaluation will enable the audiologist or dispenser to select and fit a hearing aid to your individual needs.

If you have reservations about your ability to adapt to amplification, you should inquire about the availability of a trial-rental or purchase-option program. Many hearing aid dispensers now offer programs that permit you to wear a hearing aid for a period of time for a nominal fee after which you may decide if you want to purchase the hearing aid.

Federal law restricts the sale of prescription hearing aids to those individuals who have obtained a medical evaluation from a licensed physician. Federal law permits a fully informed adult to sign a waiver statement declining the medical evaluation for religious or personal beliefs that preclude consultation with a physician. The exercise of the waiver is not in your best interest and its use is strongly discouraged.

Compliance

DISPOSAL OF INSTRUMENTS



Waste from electronic equipment must be handled according to local regulations.

ENVIRONMENTAL CONDITIONS

During transport or storage, the temperatures should not exceed the limit value of -20° to 60°C, (-4° to 140°F) 0 to 90%, 700 hPa to 1060 hPa. Battery should be removed from the device while transporting or storing.

Operating Condition: your hearing instruments are designed to operate beyond the range of temperature comfortable to you, from 0° to 50°C (32° to 122°F)



Manufactured by:
Etymotic Research, Inc
61 Martin Lane
Elk Grove Village, IL 60007 USA

Distributed by:
Lucid Hearing Holding Company, LLC
PO BOX 535596
Grand Prairie, TX 75053

Transport & Storage

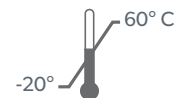

0 to 90%
700 hPa to 1060 hPa

Operational Conditions



15-90% RH non-condensing
700hPa to 1060 hPa

IP22 Protection against dripping water at all angles
Protection against objects → 12.5 mm in diameter



Type B
applied part



Read
Instructions

PATENT #US8022775

Battery Information

Battery Safety Information

Hearing aid batteries are dangerous if swallowed. Keep out of the reach of children or anyone who may accidentally swallow them. Never put batteries in your mouth for any reason. Do not store batteries in pill containers where they may be mistaken for medication and swallowed. Use batteries recommended by your hearing care professional. Batteries of low quality may leak and cause bodily harm. Batteries with incorrect voltage may cause damage to your device. Never attempt to recharge your batteries. They may explode and cause serious injury. Do not expose your batteries to heat, such as an open flame, microwave, or oven. There is a risk that they will explode and cause serious injury. Please discard old batteries in a safe place.

Visit <http://www.poision.org/prevent/battery.asp> to learn more important information about battery safety.

If a battery or hearing instrument is swallowed, see a doctor immediately and call the National Capital Poison Center **202.625.3333**.

 **WARNING**
Risk of fire and burns. Do not open, crush, heat above 60°C/131°F or incinerate. Do not short circuit. If bulges severely, discontinue use.





powered by **Lucid**[®]

[americahears.com](https://www.americahears.com)